

NESC Lever Trim for 9800/9860V Series

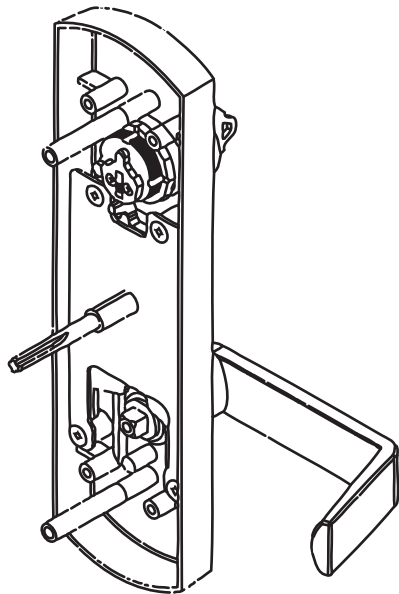

Instructions for reversing hand of lever, LHR

1. Rotate lever to LHR positioned at 90 degrees



2. Place and fasten cam piece with locked type washer and screw

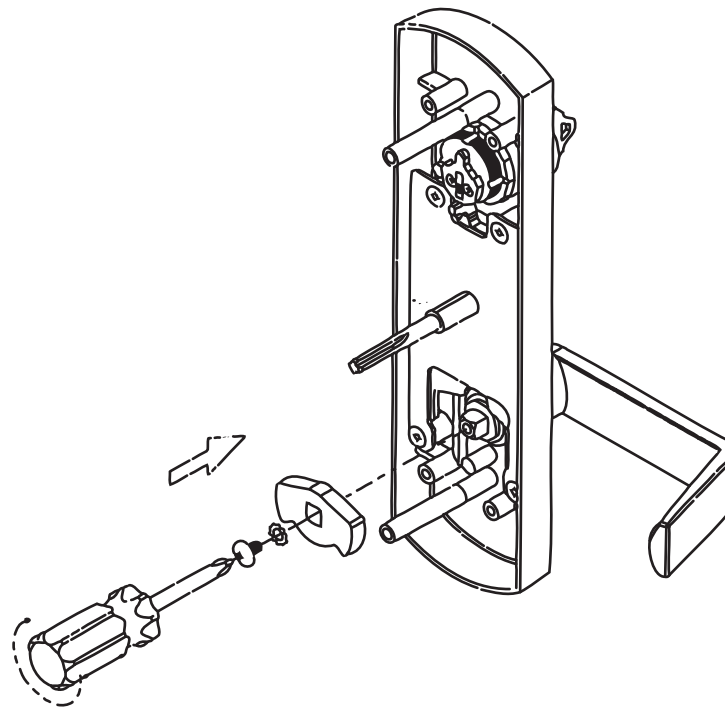

3. Done

